

F614 / F624 / F628

Fully-Lugged Lever Operated
Butterfly Valves



F624

PN16

Features & Benefits

- Aluminium Bronze disc
- Stainless steel shaft
- Trigger lever
- Valves are suitable for use with flanges conforming to BS EN 1092-2 PN10 or PN16
- F624 is WRAS approved

Materials

PART	MATERIAL
Body	Ductile Iron ASTM A536 (Epoxy Paint)
Disc	Aluminium Bronze
Liner (F614)	Nitrile Temp. -10 to 90°C
Liner (F624)	EPDM (WRAS Approved) Temp. -10 to 100°C (80°C WRAS)
Liner (F628)	EPDM (High Temperature) Temp. -10 to 130°C
Shaft	Stainless Steel Type 410
Taper Pin	Stainless Steel Type 316
Key	Carbon Steel
O-Ring	Buna-N
Bushing	PTFE
Lever & Screw	Carbon Steel (Epoxy Paint)
Stop Plate	Carbon Steel (Zn Plated)

Dimensions & Weights

SIZE (mm)	WEIGHT (kg)	A (mm)	B (mm)	C (mm)	D (mm)	E (mm)	F (mm)	G (mm)
50	4	195	80	44	32	102	260	53
65	4.5	207	89	48	32	121	260	64
80	7.2	213	95	48	32	130	260	79
100	12.6	232	114	54	32	171	260	104
125	13.5	245	127	57	32	197	260	123
150	14.9	257	140	57	32	219	260	156
200	24.1	305	175	63	44	268	356	203



GENERAL VALVES

Dimensional Drawing

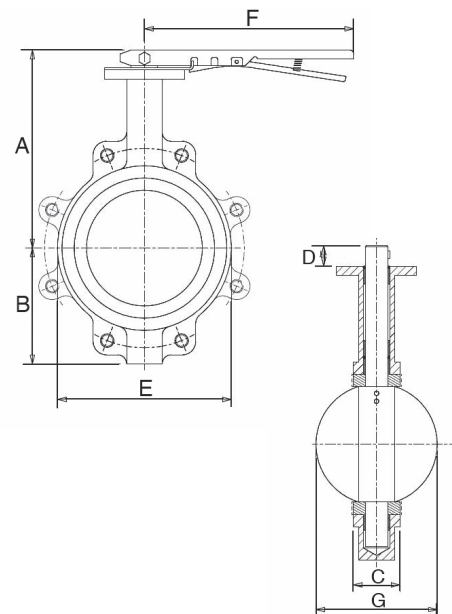

All dimensions are nominal.

Pressure/Temperature Ratings

	F611	F621	F626
TEMPERATURE (°C)	-10 to 90	-10 to 100	-10 to 130
PRESSURE (BAR)	16	16	16

Intermediate pressure ratings shall be determined by interpolation.

WRAS approved -10 to 80°C

SPECIFICATION: Conforms to: BS EN 593: 2009

F614 - Suitable for Group 1 and 2 gases and Group 1 and 2 liquids as defined by the Pressure Equipment Directive 97/23/EC.*

F624 - Suitable for Group 2 liquids only as defined by the Pressure Equipment Directive 97/23/EC* and these valves are WRAS approved.

F628 - Suitable for Group 2 liquids only as defined by the Pressure Equipment Directive 97/23/EC.*

* See page 230 for more information

Valid as of 261114

Every effort has been made to ensure that the information contained in this publication is accurate at the time of publishing. Crane Ltd assumes no responsibility or liability for typographical errors or omissions or for any misinterpretation of the information within the publication and reserves the right to change without notice.